

HART

S P O R T

PLAY ON



HART BK5000 BASKETBALL TOWER

PRODUCT CODE: 4-456



PREPARATION

PLEASE READ THIS PAGE CAREFULLY

Remove all parts and hardware from the carton and place them on a clean soft surface. Check carefully to make sure nothing is missing. Dispose of all packaging materials properly. Please recycle.



SAFETY INSTRUCTIONS



FAILURE TO FOLLOW THESE SAFETY INSTRUCTIONS MAY RESULT IN SERIOUS INJURY OR PROPERTY DAMAGE AND WILL VOID WARRANTY.

Owner must ensure that all players know and follow these rules for safe operation of the system.

To ensure safety, do not attempt to assemble this system without following the instructions carefully. Check entire box and inside all packing material for parts and/or additional instruction material. Before beginning assembly, read the instructions and identify parts using the hardware identifier and parts list in this document. Proper and complete assembly, use, and supervision are essential for proper operation and to reduce the risk of accident or injury. A high probability of serious injury exists if this system is not installed, maintained, and operated properly.

- If using a ladder during assembly, use extreme caution.
- Check base regularly for leakage. Slow leaks could cause the system to tip over unexpectedly
- Seat the pole sections properly (if applicable). Failure to do so could allow the pole sections to separate during play and/or during transport of the system.
- Climate, corrosion or misuse could result in system failure.
- If technical assistance is required, contact Customer Service.
- Minimum operational height is 6' 6" (1.98m) to the bottom of backboard.

Most injuries are caused by misuse and/or not following instructions.

Use caution when using this unit.



WARNING



- Manufacturer recommends filling the base with sand, not water. If you choose to use water, ALWAYS check for leaks. Leaking water will lighten the base and cause the system to become unstable and tip over.
- Empty water completely from the base, or add 2 gallons (7.57 liters) of anti-freeze, before the temperature approaches or falls below the freezing point. Freezing water may crack the base and cause leaks. This will result in failure of the system, and could result in serious injury.
- For residential use only! NOT for commercial use! DO NOT use this product for other than its intended purpose. Any commercial, public, or institutional use voids all warranties.

A Backboard

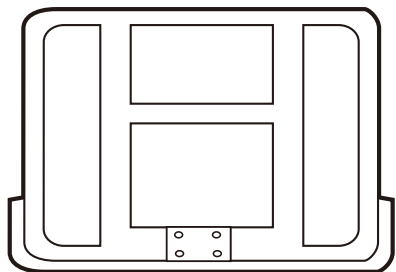

x1

B Rim/Net



B-1



B-2

x1

C Base

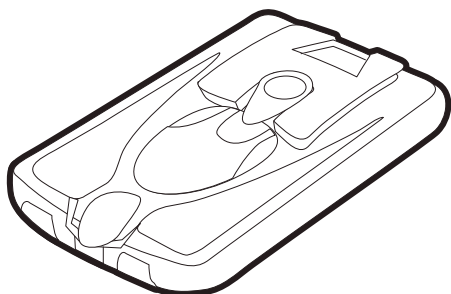

x1

D Bottom Pole



x1

E Middle Pole



x1

F Top Pole



x1

G Support arm

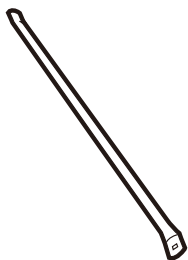

x2

H Wheels

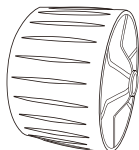

x2

I Wheels Axle

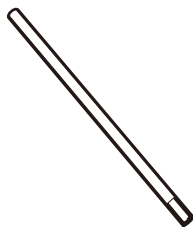

x1

J V-Bracket



x1

K U-Bracket



x1

M Top Pole Cap



x1

O Lower Arms (Long)

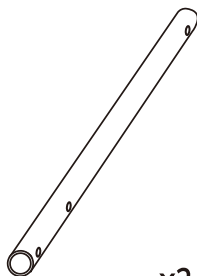

x2

P Upper Arms(Short)

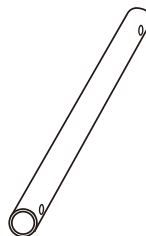

x2

L Height Adjuster Cap



x1

N Spring



x2

Q Height Adjuster



x1

R Plastic Mat(Long)

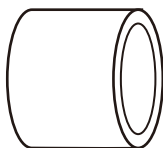

x8

S Height Adjuster Handle



x1

T Plastic Mat(Short)



x2

U Bracket Tube



x2

V Lock Nut



x17

M5 x1 M10 x2
M8 x9 M12 x5

W Washer



x35

M5 x1 M10 x4
M8 x20 M12 x10

X Spring Cap



x2

Lock Nuts Details

V-1 M5



x1

V-2 M8



x9

V-3 M10



x2

V-4 M12



x5

Washers Details

W-1 M5



x1

W-2 M8



x20

W-3 M10



x4

W-4 M12

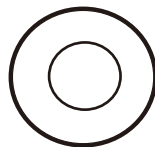

x10

Assembly Required

Adjustable Spanner

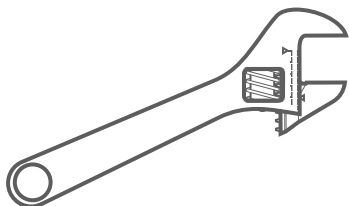

Wrenches

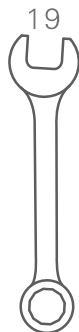
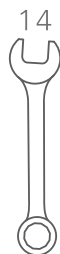

M10 x90mm



1 x2

M8 x16mm

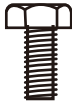

2 x4

M8 x20mm



3 x2

M8 x100mm



4 x2

M12 x180mm



6 x5

M8 x 40mm



5 x2

M8 x 65mm



7 x1

M5 x 25mm



8 x1

M8 x 90mm



9 x2

Do...

Keep your face and mouth away from the rim and net during play. If your teeth or face come into contact with the rim and net, serious injury can occur.

When adjusting the height or moving the system, keep your fingers and hands away from the moving parts.

Ensure the surface beneath the base is flat and free of stones, gravel, or any other debris which may puncture the base. If leakage occurs the system may topple over.

Check system before each use for loose fittings, wear and tear or any other signs of instability. Tighten any loose fittings.

Keep water and organic material away from the pole. The pole could rust and fall.

Once a month check the pole and all metal parts for rust.

Do Not...

Do not hang from the rim.

Do not wear jewellery during play, it may become entangled with the net.

Do not slide or climb onto the base or pole.

Do not leave the system standing upright without having filled the base with water or sand.

Do not allow children to adjust the height or move the system.

Do not use the system in windy or severe weather conditions. System may tip over. Place system in an area protected from the wind or in an area away from property that may be damaged if the system falls.

Do not use near overhead power lines.

Do not hang anything off the rim or backboard and do not use the system to lift or hoist anything.

STEP 3



Please make sure the bracket is in correct position before tighten it with backboard.

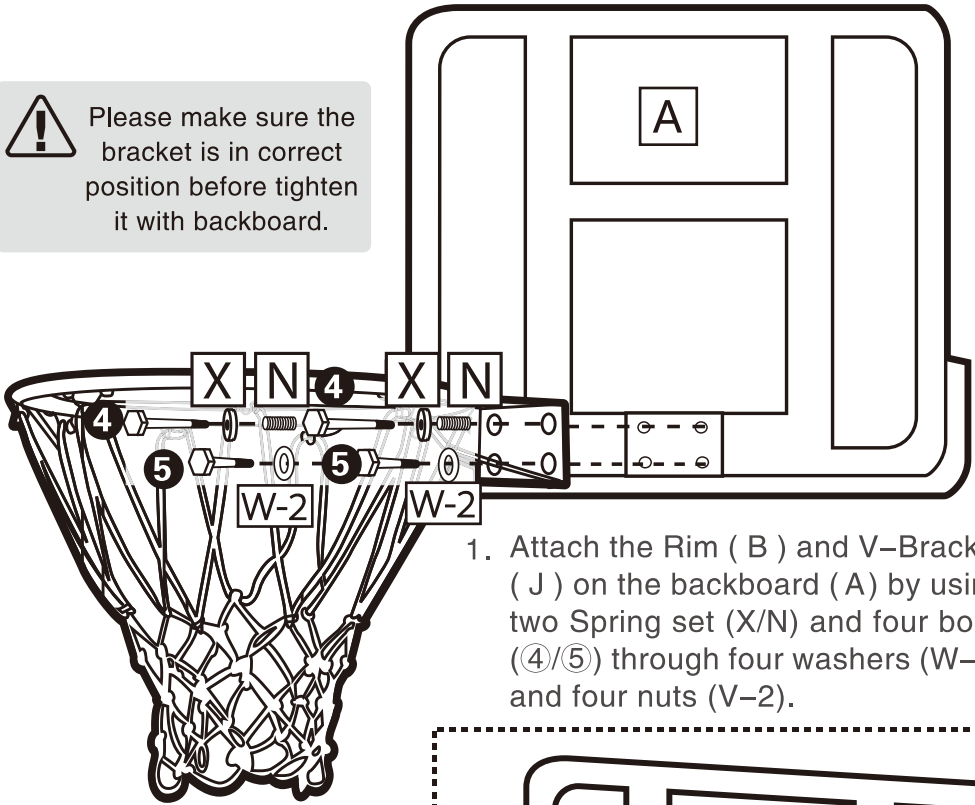

1. Attach the Rim (B) and V-Bracket (J) on the backboard (A) by using two Spring set (X/N) and four bolts (4) through four washers (W-2) and four nuts (V-2).

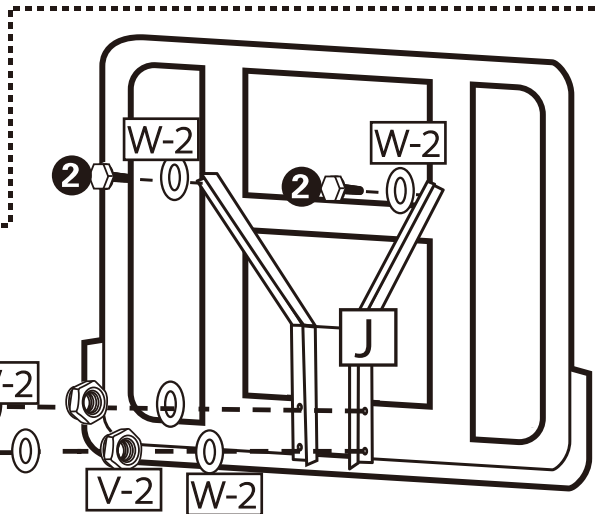

2. Open the V-Bracket to align at the joint of the backboard, secure it with two bolts (2) and two washers (W-2).

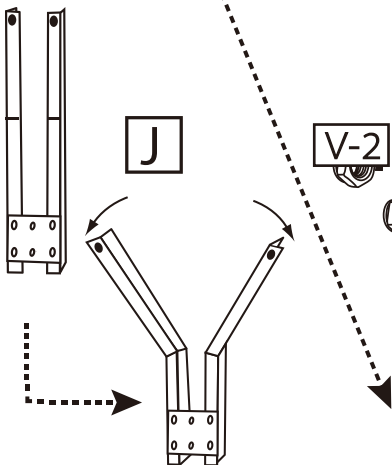

STEP 4

Net and Rim assembly

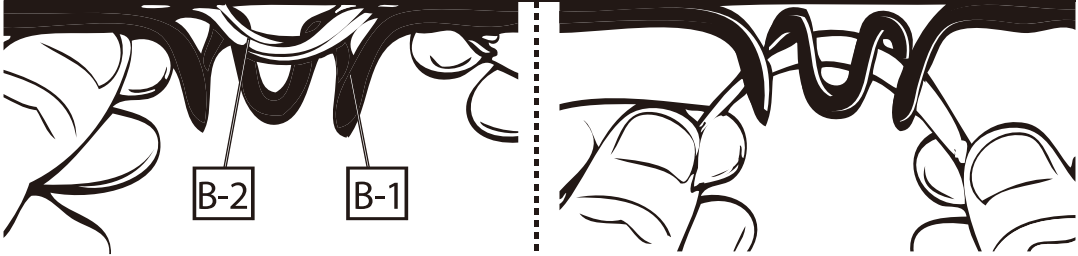

Find loops at top edge of net (B-2). Hook one loop over and around center of rim hook (B-1). Pull loop down to secure loop within rim hook. Repeat for remaining net loops.

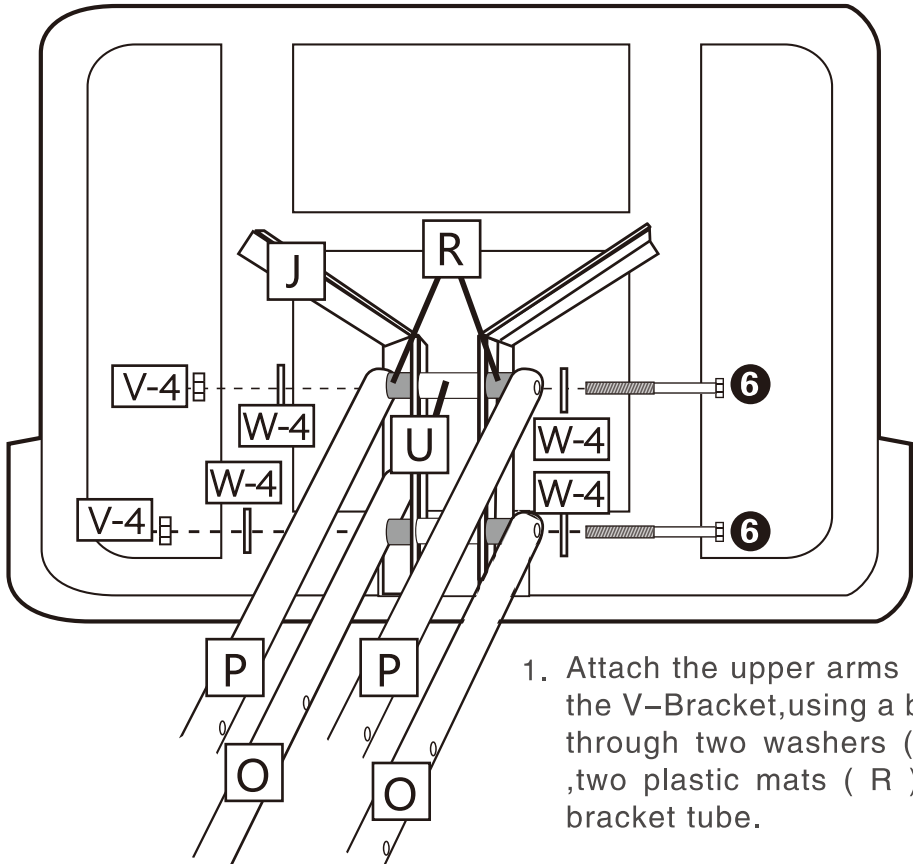

1. Attach the upper arms (P) on the V-Bracket, using a bolt (6) through two washers (W-4) , two plastic mats (R) and a bracket tube.
2. Attach the lower arms (O) on the V-Bracket in the same way above.

Make sure the mats and washers in the right position as the figures showing to avoid unnecessary troubles.

STEP 5

1. Attach the upper arms and lower arms (O/P) on the top pole by using two bolt (⑥) through four washers (W-4), four plastic mats (R) and two nuts (V-4).

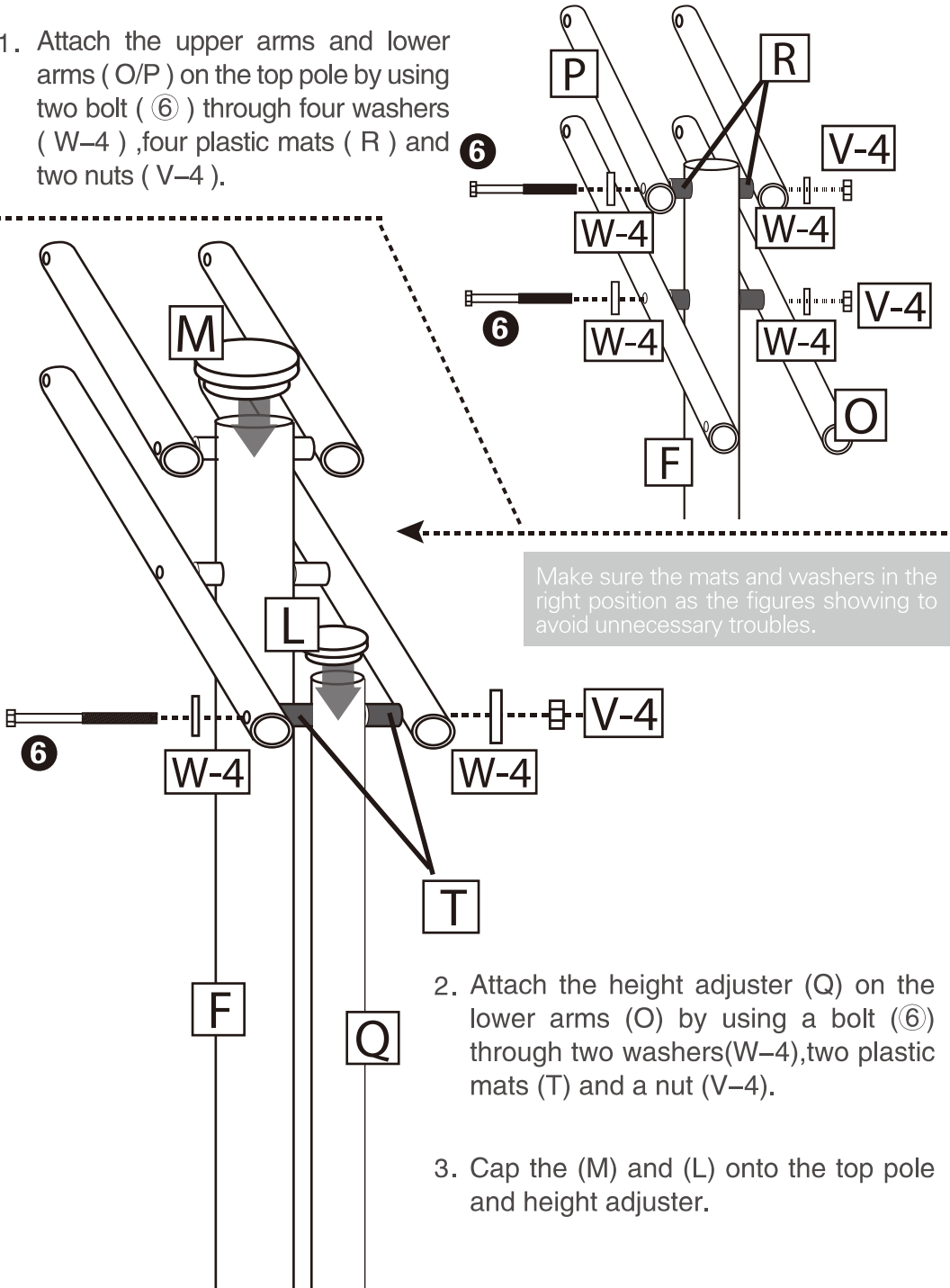

Make sure the mats and washers in the right position as the figures showing to avoid unnecessary troubles.

2. Attach the height adjuster (Q) on the lower arms (O) by using a bolt (⑥) through two washers(W-4),two plastic mats (T) and a nut (V-4).
3. Cap the (M) and (L) onto the top pole and height adjuster.

STEP 6

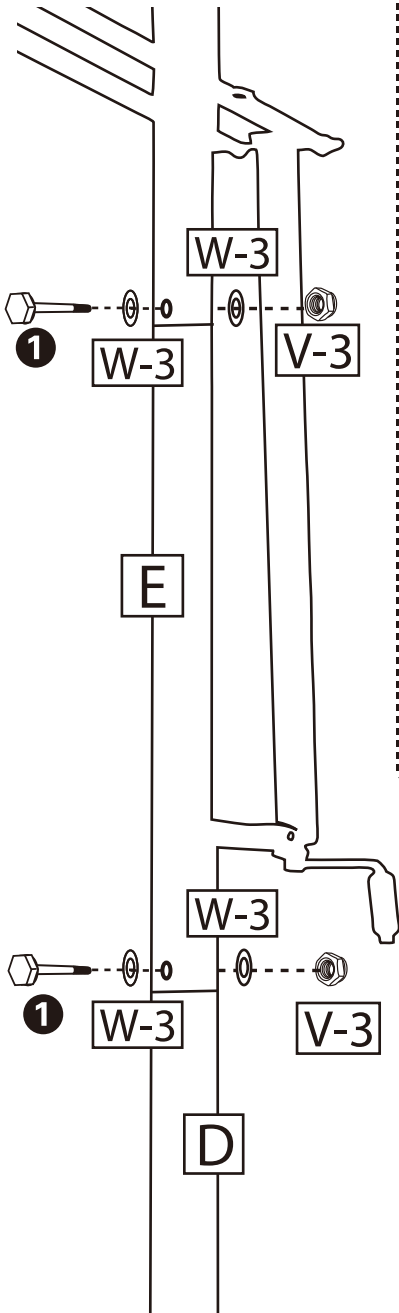

Adjust the height adjuster to a suitable height in order to connect the height adjuster and U-Bracket properly.

1. Attach the height adjuster (Q) on the U-Bracket (K) by using a bolt (7) through two washers (W-2) and a nut (V-2).
2. Attach the height adjuster handle (S) into height adjuster by using a cross-head screw through a washer (W-1) and a nut (V-1).
3. Attach the top pole onto middle pole at the joint using a bolt (1) through two washers (W-3) and a nut (V-3) to secure. Assemble the middle pole and bottom pole in the same way.

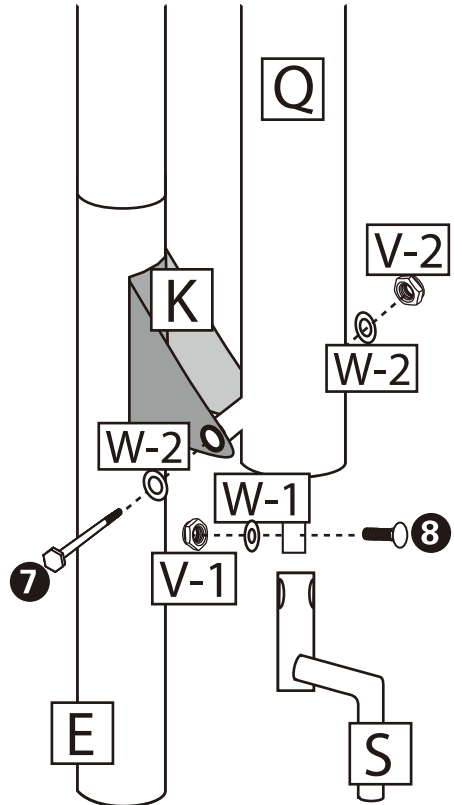

STEP 7

1. Place base where it will be used. Unscrew and remove base cap .
2. First adult: Tip base up at a 45° angle.
3. Second adult: Carefully pour sand into base.
4. Allow sand to slide into lower end of base near the wheels. Gradually lower base as sand is poured to ensure sand fills entire base. Once full, replace base cap.
5. If filling with water, DO NOT tip base up.



Warning



- Two capable adults required for this step.
- NEVER leave system in upright position without proper weight in base ,or the system will tip over.
- Manufacturer recommends using sand.If using water,see warning on page 3.

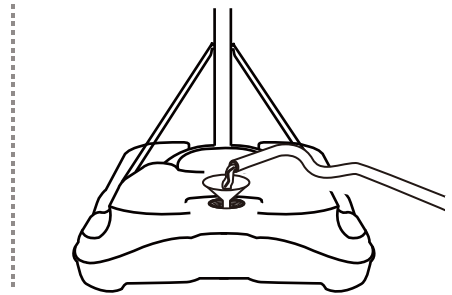
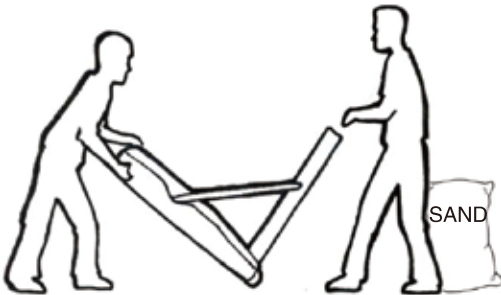

1. Adjust backboard to lowest position.
2. While holding pole and lifting base, carefully lean system forward until wheels touch ground.
3. While holding pole and base, roll system to desired location.
4. Stand pole upright and set base flat on ground.
5. ALWAYS check to make sure system is stable in new location.

